



Determinants of AI Non-Fungible Tokens Gaming and Blockchain based Digital Marketing: A Revolution of Metaverse in Asia Pacific Region

Hafiz Muhammad Adeel Siddique¹, Rana Muhammad Shahid Yaqub², Hafiz Muhammad Zeeshan Akram³, Rashid Khurshid⁴

¹ Postgraduate Research Scholar, Department of Marketing and International Business, Institute of Business Management and Administrative Sciences, The Islamia University of Bahawalpur, Pakistan. Email: h_addi@live.com

² Assistant Professor, Department of Marketing and International Business, Institute of Business Management and Administrative Sciences, The Islamia University of Bahawalpur, Pakistan. Email: shahid.yaqub@iub.edu.pk

³ Ph.D. Scholar, Department of Marketing and International Business Institute of Business Management and Administrative Sciences, The Islamia University of Bahawalpur, Pakistan. Email: zeeshan.akram@iub.edu.pk

⁴ Ph.D. Scholar, Institute of Business Management & Administrative Science, The Islamia University of Bahawalpur, Pakistan. Email: rashid@iub.edu.pk

ARTICLE INFO

Article History:

Received: May 12, 2023

Revised: June 20, 2023

Accepted: June 21, 2023

Available Online: June 22, 2023

Keywords:

Non-Fungible Tokens (NFTs)

Digital Marketing

Television

Funding:

This research received no specific grant from any funding agency in the public, commercial, or not-for-profit sectors.

ABSTRACT

The adoption of Non-Fungible Tokens (NFTs) has witnessed a significant surge in recent years. NFTs are digital assets that operate on blockchain technology and are traded using cryptocurrencies such as Ethereum, Tezos, Solana, among others. However, there is limited knowledge regarding the economics of NFTs and people's perspectives and experiences with them. Therefore, the purpose of this research is to present diverse understandings of NFT gaming and digital marketing, analyze the benefits and drawbacks of NFTs, and explore their potential in the metaverse. This study utilizes a qualitative investigation approach involving nine respondents from the NFT, blockchain, and gaming communities. The research employs case study and descriptive analysis methods. The conclusion drawn from this study recommends the utilization of NFTs and expects readers to find this research beneficial. NFTs represent digital assets that are uniquely identifiable and traded using blockchain technology and cryptocurrencies. Despite their popularity and increasing trading prices, there is a lack of comprehensive understanding regarding the economics of NFTs, as well as people's perspectives and experiences with them. This research aims to address this gap by providing diverse insights into NFT gaming and digital marketing, exploring the benefits and drawbacks of NFTs, and investigating their potential in the metaverse. The study employs a qualitative investigation methodology and involves nine participants from the NFT, blockchain, and gaming communities. The research utilizes case study and descriptive analysis methods to gather and analyze data. The study examines the impressions and experiences of individuals engaged in crypto games. The results indicate that most players dedicate 2 to 6 hours per day to playing crypto games. Moreover, it is found that the time required recovering one's investment in these games ranges from 1 to 90 days. The findings also reveal that players are concerned about the presence of potential economic instability in a volatile market. Additionally, issues such as value manipulation, privacy, security, and trust related to the design and utilization of NFTs are highlighted. Understanding the cryptocurrency market entails understanding the motivations of individuals who engage in paid games, as their interests are crucial for any government initiatives aimed at generating revenue. The study recommends that players explore the NFT Pakistan game.

© 2023 The Authors, Published by iRASD. This is an Open Access article distributed under the terms of the Creative Commons Attribution Non-Commercial License

Corresponding Author's Email: shahid.yaqub@iub.edu.pk

1. Introduction

1.1. NFT Gaming Background

Crypto uses the chain-based mechanism. Blockchain game refers to the hosting of games using IOT technology inclusive of Ethereum. Crypto Kitties became the primary broadly diagnosed block-chain sport. Players can own, breed, and trade cats, which are the game's only medium. The worth of one cat was over \$100,000.

Figure 1: Crypto Kitties blockchain Game

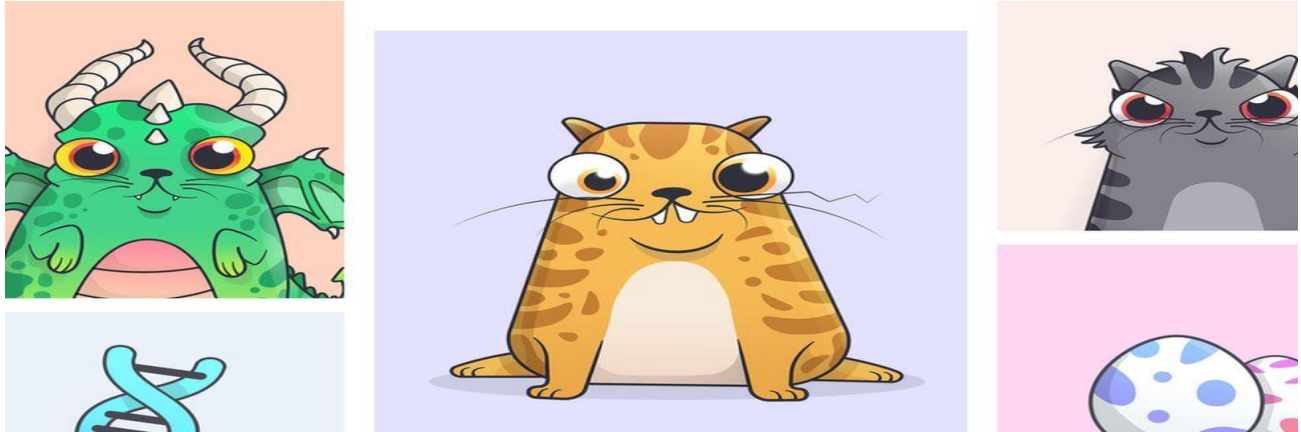

HashCraft is an innovative sandbox game in which players parachute onto a randomly generated island and start constructing their personal global.

Figure 2: Hashcrafts Blockchain Game

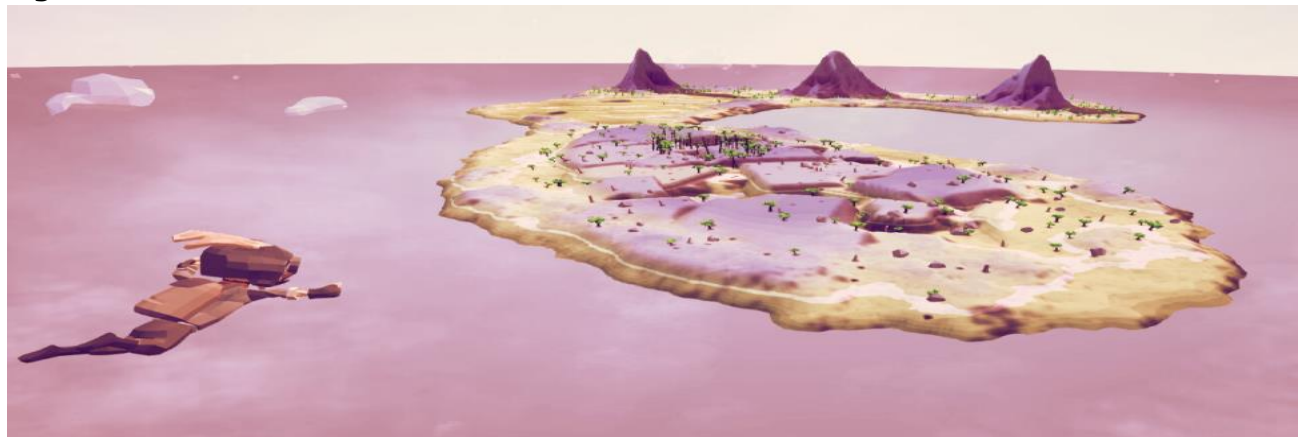

Crypto Botwars leads the military of robots to conquer the game. You can win real money and cryptocurrency rewards and equip yourself with a huge variety of guns, shields, and ammunition.

Figure 3: Botwars Blockchain Game



This most wanted game was released in 2018, Axie Infinity is one of the maximum popular blockchain video games avaRecreationcreation seems to be growing in popularity and is presently making quite a little cash. In Axie Infinity, gamers gather, breed, exchange, and conflict creatures called Axies. These creatures are digitized as collectible NFTs.

Figure 4: Axie Infinity Blockchain Game



1.2. Blockchain

There was an era when assets might be considered only those things which are physical (Like a motorbike, grain) or abstract things like stock investment (Dewey, 2021). But due to advancements in technology, assets are not only physical things a digital contract or an application can be more value able for an organization than a physical asset.

Figure 5: Blockchain Representation

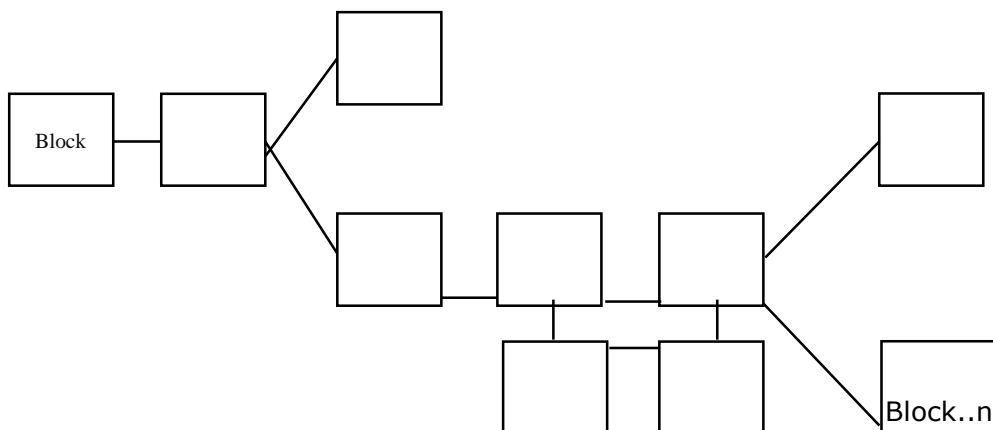

Organizations all over the planet have been creating strong applications utilizing Blockchain innovation. The monetary area, including banks and other installment handling establishments, has started investigating ways of integrating innovation into their frameworks to further develop effectiveness, security, and speed of exchanges and data. Few models are, blockchain can be utilized to work on the productivity and straightforwardness of monetary business sectors by making a conveyed record that records all exchanges made in digital currencies or different resources. This permits members to see the record without first really looking at it with an outsider, like a bank or government, to assist with forestalling extortion. Another one is medical care, blockchain innovation further develops clinic production networks the executives by safely putting away persistent data in a scrambled data set to deal with clinical issues, for example, guarantee handling and drug store administering records (e-Health Insurance).

Figure 6: Application of Block chain



The possibility of Bitcoin was that it would work much the same way as actual cash or gold, however, the significant element is that exchanges made utilizing bitcoin are super durable and irreversible (Frankenfield, 2022).

1.3. Creation & introduction of NFTs

With regards to sending off a fruitful NFT assortment, Planning is vital. The workmanship and illustrations are cool and significant yet a solid arrangement is basic. I would reduce it down to the scandalous, five Ws' during Planning. Planning is vital after designing of an NFT. How much an NFT is successful it all depends upon the planning how to launch and market it. Five Ws' are considered most important for the strategic planning. Toward the start of 2021, we encountered an NFT blast that carried the innovation to superstars and standard financial backers the same. It likewise saw the formation of millions of NFT workmanship pieces which filled in as independent works with no genuine utility beyond a store of significant worth.

1.4. Research Problem

Most game development studios and developers in Pakistan are commonly centered on creating games for popular or mainstream structures together with STEAM or in the case of cell video games for the Google Play Store. Little to no work is presently being posted on stores consisting of Epic Games, Riot Games, and so forth. Around the globe, many countries have made proper management and the installation of digital ATMs' which are being used by the customers and users of NFT (cryptocurrency) trading and their transaction purposes. However, the emergence of artificial intelligence (AI) has brought a significant change in the gaming industry, with the creation of Non-Fungible Tokens (NFTs) that enable players to own and trade unique digital assets through blockchain technology. NFT games have disrupted traditional gaming models, offering new business opportunities that could potentially enhance the economy of Pacific Asia. Despite the potential benefits of NFT games, little is known about the determinants of their success and the strategic business models that can maximize their potential. Currently, there is no literature available that focuses on building AI-driven NFT games that offer payment on playing and winning games while also providing rewards for digital marketing efforts using blockchain technology. This gap in knowledge is particularly pronounced in Pacific Asia, where the NFT gaming market is rapidly growing and presents a unique opportunity for economic development.

1.5. Research Questions

Despite so popularity and development of Block chaining & NFT technology there is no research development & studies in Pakistan. This is the still in infancy stage in Pakistan. People have no idea about block chaining. The motivation of this research is to propose an intelligent approach for the adoption of NFT --- NFTs games in Pakistan. This exploration may give promising results by identifying opting NFTs' games in Pakistan. This study is used to look at an early effort to explore the issues and give a solution in the form of "COMMUNITY WAR/POOL". Research work is carried out to explore and find out the following question:

- What is NFT gaming's role towards the globe development?
- Why does Pakistan be far behind in NFT Gaming World?
- How Community War contributes to the NFT Games in Pakistan?

1.6. Scope of the Research

This research goal is to question using the non-fungible token game (NFT) in Pakistan to reinvent the possession structure via the tokenization of property that has lately been incorporated with the growth of the blockchain application. This thesis intended to recognize people's belief in the concept of tokenization through NFT via the nuances of making cost the use of the classical monetary principle.

The gaming industry offers a wide variety of career options. In terms of employment, we also cater to a wide range of segments. According to statistics shared by the AGA (American Gaming Association), the gaming industry employs 1.7 million people, with an annual employment rate of 62,000 (average) growth. The objective of the Research are, IGDA (International Gaming Development Association) estimates that Pakistan's gaming enterprise generates \$25 million yearly. As of 2019, over 8000 experts were operating in the video gaming sector. Shortage, Transparency and Unambiguous, despite online game development studios the world over generating numerous properly-acclaimed titles, Pakistan has no longer been able to foster better expertise for online game development. Here are some motives why Pakistan has been unable to harbor better expertise in video game development: Most developers in Pakistan focus on creating games for certain platforms such as mobile games like Google Play Store. Currently, a very little bit of work has also been done for stores like Epic Games, Riot Games, etc.

The major contributions of this research work are, while there are advantages to using NFTs in games, there are also many challenges to overcome. In particular, NFTs need to be made more attractive and accessible to ordinary Pakistani consumers who are not necessarily tech-savvy. Due to the intrinsic value of NFTs, some may be treated as speculative assets. This possibility may lead players to purchase in-game assets in hopes of later marketing them for profit, rather than using them as intended in the game's ecosystem.

Table 1: Some Published Work (Studied as SLR)

Author	Topic	Publication Year
Ayesha Afzal, Aiman Asif	Crypto currencies, Blockchain and Regulation: A Review	2019
Stefano Reverberi	NFT and the Work of Art in the Era of Digital Reproduction: Insiders' Perspective on Blockchain's Effects in the Digital Art Domain	2021
Crew Cattanach	Axie Infinity: online games where people earn as they play are transforming gaming	2021
Ayesha Ashraf , Alia Manzoor, Malka Liaquat, Najma Yasmeen	Cryptocurrency perspective: the drivers leading from awareness to adoption- a case of pakistan	2021
Kensuke ITO, Kyohei SHIBANO, Gento MOGI	Bubble Prediction of Non-Fungible Tokens (NFTs): An Empirical Investigation	2022

Despite these hurdles, the potential gains for the gaming industry are more focused on chain-based games, perhaps by partnering with third-party blockchain initiatives with corresponding technical expertise. Will encourage the Pakistani gaming industry to try NFTs. Here is the list of some published and research work related to NFTs' games.

2. Literature Review

The gaming industry has undergone a significant transformation in recent years, thanks to the emergence of new technologies such as Artificial Intelligence (AI) and blockchain. Non-Fungible Tokens (NFTs) are a product of the intersection between these two technologies and have gained considerable attention in the gaming industry.

The use of non-fungible tokens (NFTs) in gaming has opened up new opportunities and business models for the industry. The gaming industry has witnessed tremendous growth over the years, and the integration of AI technology is expected to take it to new heights. This literature review aims to explore the determinants of AI revolutionary NFT game and business model stratagem and its potential to raise the economy of Pacific Asia.

2.1. Determinants of AI Revolutionary NFT Game and Business Model Stratagem

The use of AI in the gaming industry has been growing rapidly in recent years. AI can be used to improve the gameplay experience, create more realistic environments, and enhance player engagement. One of the key benefits of AI in gaming is its ability to create dynamic and adaptive game environments, which can provide a more immersive experience for players (Yannakakis & Togelius, 2018). AI can also be used to personalize the gaming experience for individual players, based on their preferences and behaviors (Yannakakis & Togelius, 2018). In their study, "The Rise of Non-Fungible Tokens and Their Potential for Gaming," Hanke et al. (2021) examine the potential of NFTs in the gaming industry. AI technology has played a crucial role in the development of NFT games. AI-powered NFT games provide a unique gaming experience and are attracting more users. AI technology can be used to generate NFTs that are more sophisticated and with unique features that add value to the game. In their study, Chen and (Chen, Guo, Gao, & Liang, 2021) found that AI-based gaming strategies significantly improved players' performance and satisfaction. AI-powered NFTs can also be used to create more complex game mechanics that require players to collaborate and strategize. As noted by (Li, Li, Yuan, & Zhu, 2021), AI-powered NFTs can lead to a more personalized gaming experience that is tailored to the individual preferences of players. As highlighted by (Xiao, Zhang, Zhu, Hu, & Cao, 2023), AI-powered graphics and audio can lead to a more immersive and engaging gaming experience, which can result in increased player engagement and revenue for developers.

2.2. Non-Fungible Tokens in Gaming Industry

NFTs allow game developers to create rare and valuable in-game items, such as weapons or skins, which can be traded between players (Liu et al., 2023). NFTs also provide a new revenue stream for game developers, who can earn a commission on each transaction. A few models from the actual world are works of art, visiting & business cards, and show passes. Note that you can't divide these resources into more modest units, in contrast to fungible ones. NFTs permit applying these non-fungibility attributes in the computerized world (Cass, 2022).

Figure 7: Sale Report 2 August 2022 to 9 August 2022

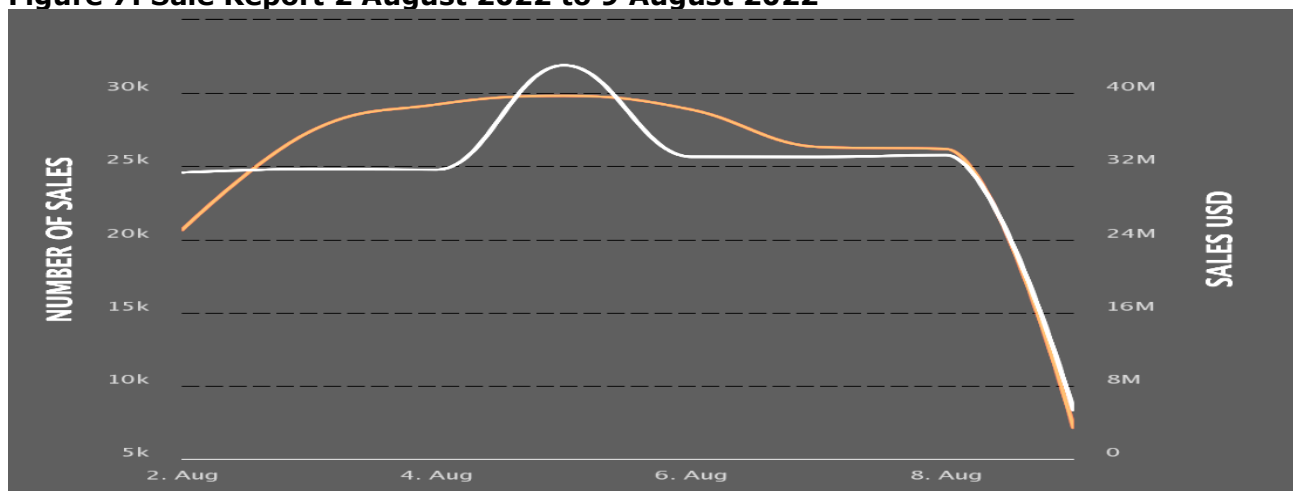

Many individuals are purchasing NFTs, trusting they'll have the option to sell them for benefit. It's the beanie child frenzy for the computerized age (Heilbuth, 2022). In this study Table 2, represents the performance of NFT during 2022, the first quarter, and the second quarter all around the world.

Table 2: Global NFT Performance Chart(besancia, 2022)

Descriptions	Quarter 1 2022	Quarter 2 2022
USD traded	\$10,734,200,304	\$8,070,349,275 -24.82%
Volume of Sale	\$12.639,781	\$10,106,967 -20.05%
Buyers	\$1,571,566	\$11,172,235 -25.41%
Sellers	\$903,771	\$579,513 -35.88%
Active wallets	\$1,864,820	\$1,247,083 -33.13%
Profit	\$3,502,706,752	\$1,888,762,534 -46%
Loss	\$-1,155,116,672	\$-1,427,612,570 -23%
Average Ownership	30.9	47.9 +55%
Active Smart Contract	11,848	15,315 +29.26%
Average Price	\$849	\$798 -6.01%

2.2.1. Creation of NFT

One more significant first thing to know is that NFTs are costly to make, keep up with, and sell. Some NFT commercial centers at present help free issuance of NFTs for purchasers, however by and large makers need to pay to give their NFTs regardless of whether they sell them (Dean, 2022). The initial step required in creating and commercializing a Non-Fungible Token (NFT) involves the process of "minting" the NFT, assuming the possession of the artwork intended for NFT conversion. The minting procedure necessitates the selection of an appropriate NFT platform alongside a payment wallet, the latter serving the purpose of funding the associated fees and receiving potential payments upon successful NFT sales. For illustrative purposes, the present study employs Rarible as the chosen NFT platform, accompanied by MetaMask as the designated payment wallet. It is important to note that multiple alternative options exist within this domain (Dean, 2022). The procedure is very simple. You can follow these steps.

- Choosing a wallet
- Set up a digital wallet
- Adding crypto currency to wallet
- Associate wallet to a NFT platform
- Upload the record you need to transform into as NFT
- Setup auction method
- Add details to sell NFT
- Pay fee to sell NFT

2.3. Business Model Stratagem

The convergence of Artificial Intelligence (AI) and Non-Fungible Tokens (NFTs) holds immense promise for the emergence of innovative business paradigms within the gaming industry. Among the potential models that can be explored, the establishment of decentralized autonomous organizations (DAOs) stands out prominently. DAOs operate through the execution of intelligent and self-executing contracts on blockchain platforms, thereby introducing a novel framework for managing and governing gaming-related ventures (Liu et al., 2023). DAOs can be used to govern in-game economies and provide a transparent and fair distribution of rewards to players. Another potential model is the use of AI to personalize in-game advertising, which can increase revenue for game developers (Yannakakis & Togelius, 2018). As noted by (Chen et al., 2021), the revenue-sharing model in NFT-based games can lead to increased player engagement and revenue for developers.

The sale of NFTs can also help to fund the development of new games, leading to the creation of a sustainable gaming industry. As highlighted by Hsu et al. (2021), the sale of NFTs can also lead to increased revenue for players who can buy and sell NFTs in the game's marketplace. As noted by (Li et al., 2021), this collaboration between players and developers can lead to increased player engagement and revenue for developers. Computer games are normal mechanisms of diversion for people in different age ranges. The presentation of NFT computer games prompted the improvement of a more different crowd. NFT games have turned into a well-known mode of diversion (ixie gaming, 2022). For example, Crypto Kitties features a modest number of contracts that organize the game. The most well-known is their gene science contract, which specifies the spontaneous techniques to produce new cats. The codes are kept a secret at the start. Interested parties even constructed tools to calculate the likelihood of specific cat features appearing (Sherry, Greenberg, Lucas, & Lachlan, 2012).

2.4. Potential Impact on the Economy of Pacific Asia

The gaming industry is a significant contributor to the economy of Pacific Asia, particularly in countries such as China, South Korea, and Japan. The use of AI and NFTs in gaming has the potential to create new revenue streams and business models, which could contribute to the growth of the gaming industry in the region. Pacific Asia has shown potential for the development of NFT-based games and business models. As noted by (Chen et al., 2021), the promotion of regional stability and security has helped to attract foreign investment and contributed to the region's economic growth. The region has a large population of gamers, and a growing tech industry. Additionally, governments in the region have shown support for the development of blockchain technology. As noted by Kim and Kim (2018), infrastructure development has helped to create new opportunities for trade and investment, contributing to the region's economic growth.

The gaming industry in Pacific Asia has witnessed significant growth in recent years. The region has a large population of gamers, with China, Japan, and South Korea being the largest gaming markets in the region. As noted, the development of innovative industries has helped to create high-skilled jobs and contributed to the region's economic growth. As highlighted by Huang and Kao (2019), the growth of intra-regional trade has helped to promote economic growth and stability in the region.

2.5. Block Chain

Several new technologies have emerged in various sectors of the global economy in the recent technological period. As a corollary, blockchain technology has become one of the biggest and most popular, widely employed in financial institutions blockchain technology emphasizes the importance of safeguarding transactions. The technology of blockchain has revolutionized record-keeping and monitoring through its decentralized and immutable nature. Acting as a distributed ledger, blockchain simplifies the process of tracking and verifying various types of assets. These assets can range from tangible properties like homes, vehicles, and land to intangible entities like businesses and intellectual property. By leveraging the capabilities of blockchain, the management and authentication of both physical and abstract assets are streamlined, contributing to increased transparency and efficiency in diverse sectors (Dewey, 2021).

Blockchain is used to empower cryptographic money yet has since been broadly promoted for changing whole industries' potential. The technology at the core of this concept manifests as a shared data set consisting of discrete sections that require validation from distributed networks and encryption (Huynh-The et al, 2023). Beneath, we've illustrated a portion of its arising t applications across finance, business, government, and different enterprises (Maloul & Chevalier).

A Blockchain is just an assortment of records of time-stepped exchanges that are overseen by a gathering of servers (Celik, Petri, & Barati, 2023). There is no focal power that controls the information base. It tends to be refreshed by agreement between members in the organization, and another exchange is recorded that can never be deleted or altered. Yet, the unavoidable issue is how does a Blockchain function? Here is the working procedure of Blockchain categorized into the following steps (Sharma, Namasudra, Chilamkurti, Kim, & Gonzalez Crespo, 2023).

Figure 8: BlockChain

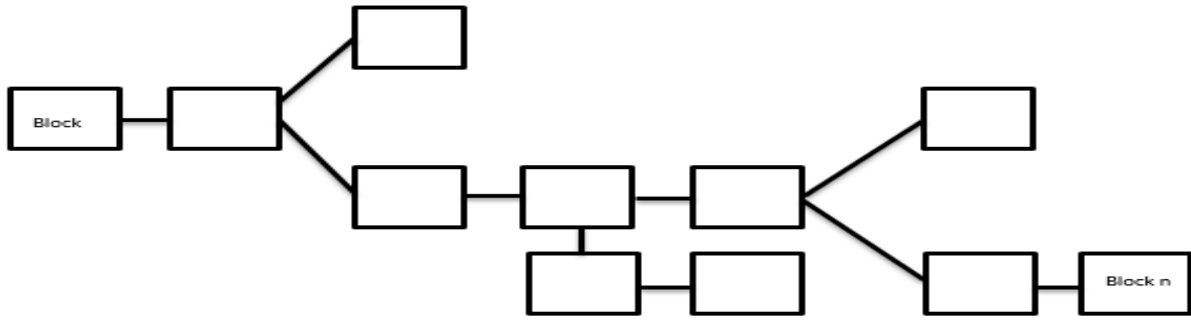

Step1: We should assume two clients in a Blockchain organization, Alex and Brown, need to make another exchange. Alex sends 50 BTC to Brown. They will demand the exchange to be mined. Step 2: The exchange can occur if the wide range of various members in the organization checks it as a certified exchange. Accordingly, every client will get the solicitation to confirm the exchange between Alex and Brown. Step 3: The information of the exchange requires hash esteem now to handle the exchange. The hash capability takes any information of info and converts it into a remarkable 64-bit line of result. Every client will look at specific data about the exchange, for example, does Alex have adequate assets to make the exchange? Step 4: Then, at that point, the exchange is sent to the taking part hubs of the organization. When the check is finished, the exchange is prepared to occur. Presently, the exchange is added to the memory pool of Blockchain. Step 5: Each block has a characterized memory pool; subsequently a few other checked exchanges consolidate together to make another block of the record. There can be various exchanges in the block. Step 6: The made block is then added to the current Blockchain. Each new block will have a block header comprising of time-stamp, hash, past hash, and exchange information outline. Each block has its one-of-a-kind hash esteem, which behaves like its mark, or you can say a unique finger impression. Step 7: The block is mined with the assistance of the hash capability. After this, the exchange is finished, and cash is shipped off the subsequent person (working-of-blockchain, 2020).

Figure 8: Blockchain working

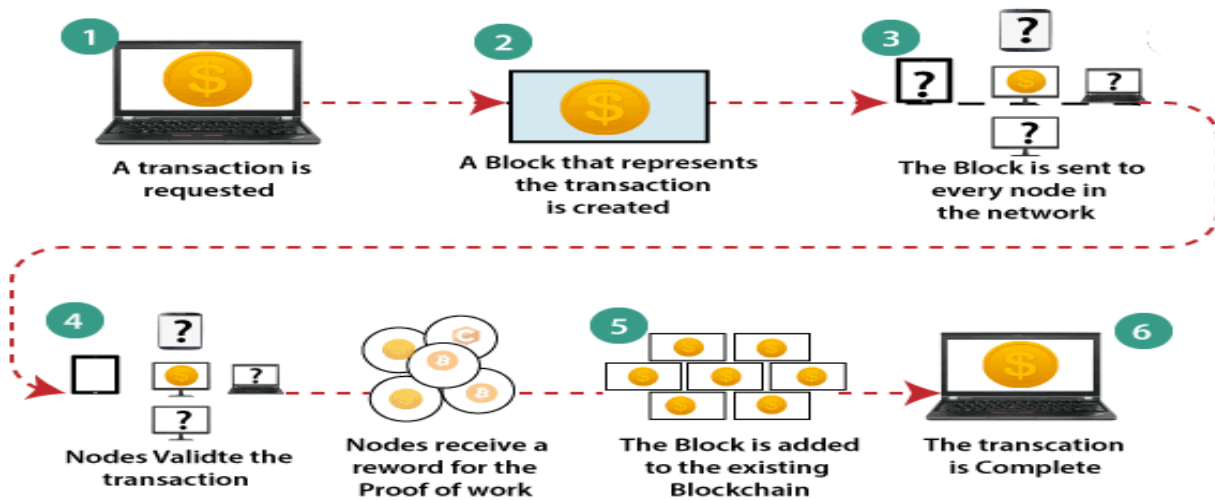

2.6. Cryptocurrency

Cash has been utilized as a mechanism of trade for around 3,000 years, following the utilization of the bargaining framework. At first, cash was wares, however as human advancements advanced to utilizing valuable items and metals or stones, this prompted the development of coins (like those pre-owned today), regularly made of gold or silver. These revenues eventually converted into cash that could be repaid in gold or silver coins. This led to the development of the highest quality level, where authorized notes evolved into notions that could be exchanged for gold. E-cash and virtual monetary standards represented new developments in money at the turn of the twenty-first century (Afzal & Asif, 2019).

Cryptocurrencies represent a form of decentralized digital currencies that operate on a peer-to-peer architecture (Lansky, 2018). However, the intricacies experienced in the

cryptocurrency market stem from the fact that the value of cryptocurrencies is not anchored to any particular country's economy, physical assets, or the fundamentals of any specific company. Instead, their value derives from algorithmic mechanisms (Corbet, Lucey, Urquhart, & Yarovaya, 2019). Consequently, cryptocurrencies diverge significantly from traditional markets such as commodities, equities, and foreign exchange (Li et al., 2021). Notably, this market is characterized by its illiquidity and high volatility, posing considerable risks to investors, capable of yielding substantial profits or substantial losses (Ciaian & Rajcaniova, 2018; Corbet et al., 2019; Gil-Alana, Abakah, & Rojo; Mba & Mwambi, 2020; Wang, Xue, & Liu, 2016).

Given the volatility dynamics, it is essential for investors to employ appropriate tools to navigate this landscape (Mba & Mwambi, 2020; Mba, Pindza, & Koumba, 2018). Consequently, as the popularity of cryptocurrencies continues to rise, an increasing amount of empirical evidence is being generated, leading to a growing body of literature analyzing volatility patterns in the cryptocurrency market (e.g., (Aras, 2021; Hattori, 2020; Mba & Mwambi, 2020; Mba et al., 2018), as well as exploring relationships between cryptocurrencies and other financial assets e.g., (Baur, Dimpfl, & Kuck, 2018; Garcia-Jorcano & Benito, 2020; Peng, Albuquerque, de Sá, Padula, & Montenegro, 2018; Sapuric, Kokkinaki, & Georgiou, 2022; Umar, Rizvi, & Naqvi, 2021; Uzonwanne, 2021). Consequently, it is of utmost importance to aggregate and synthesize existing knowledge while identifying gaps in the literature (Angerer, Hoffmann, Neitzert, & Kraus, 2021; Corbet et al., 2019).

3. Research Methodology

This qualitative exploratory study's goal was to ascertain how NFTs might be used and made profitable by developing a market to meet consumer demand. In order to determine how enhancing utility and merging utility inside a metaverse would hold the value of NFTs, it was necessary to further examine NFTs within the blockchain platform. Big players may even introduce the idea of loading NFTs into the metaverse over time, making this access option more accessible and affordable. The most recent value the NFTs had produced in 2021 alone was \$490,000,000. When interacting with the blockchain to verify the digital asset, the intelligent contracts function like escrows and instead use oracles to provide a source of truth (Ojog, 2021).

3.1. Research Design

When embarking on a research endeavor, it is crucial to employ established research techniques. Accordingly, for the present study, a qualitative approach was deemed suitable for our investigation. Qualitative research serves as an inductive inquiry method employed across numerous academic and applied disciplines. By utilizing qualitative methods, such as case studies, researchers delve into a comprehensive comprehension of natural and human behavior, as well as the underlying factors governing such phenomena. Ketokivi and Choi (2014) posit that case methodology is particularly advantageous when pursuing a theory-building approach, further affirming its suitability for the research at hand. The intended strategy was to compile qualitative survey responses from a group of users in the crypto community in order to learn more about the NFT and metaverse. The pragmatic method is centred on a what works mindset, where objectionable approaches were merged and utilised, including natural and authentic approaches.

3.2. Population and Sample Size

Users of cryptocurrency platforms would be the study's target audience. The adoption of the technology may be impacted by ensuring that the audience is aware with blockchain technologies. More emphasis was placed on targeting gamers who would be familiar with the platforms targeted as being a member of the metaverse. In this research the population of current research is all gaming community of Pakistan and selected through convince sampling which is non-probability sampling technique. The sample size of this research is 09 and this is selected through after conducting final interview of many people who are expert in different games.

3.3 Data Analysis

The research approach undertaken in this study aimed to analyze the impact of NFTs and the metaverse from the perspective of users, the gaming community, and accountants. To facilitate this investigation, a case study method was employed, involving the collection of data from both primary and secondary sources. Primary data was obtained through online interviews conducted with participants from the traditional gaming community via platforms such as Zoom

and Discord, while secondary data was gathered from reputable sources such as journals, books, and websites to support the research question. Semi-structured interviews were conducted, allowing participants to share their experiences and perspectives on NFT gaming based on predetermined topics. To mitigate bias, a moderator was present during the interviews and respondents were given the space to answer without interruptions. The collected data will undergo descriptive analysis techniques. This involves summarizing the recorded data to identify patterns, filtering out less relevant information, and assessing the alignment of interview results with the research objectives. The research objectives include understanding the perceptions of users, the gaming community, and accountants regarding NFTs and the metaverse, exploring the opportunities and challenges they encounter in this context, and gathering insights about their expectations for NFTs and the metaverse in the future.

3.4. Development of Gaming

Unity 3D has turned into a well-known choice among engineers looking to fabricate extraordinary, simple, and reasonable 2D and 3D game plans.

Figure 9: Unity Development Tool



3.4.1. Statistical Values About Unity

The top 34% of free versatile games accessible on the Play Store and App Store have utilized Unity Game Engine for advancement. Versatile games made with Unity legitimize 71% of the best 1000 titles(Unity, 2021b). There are 2.8 billion(Unity, 2021a) dynamic clients associated with content worked or made by Unity Game Engine in 2020. 5 Billion downloads each long stretch of utilizations created utilizing Unity. 94 out of the key 100 improvement studios by overall income are Unity clients (Lestiyo, 2021).

3.5. Community War Game (Community INU)

Community War is to carry amusement and satisfaction to players while remunerating them for playing the game. Nonetheless, the truth of how NFTs and NFT games end up becoming isn't true to form all of the time. This innovative game operates on a blockchain infrastructure and leverages the power of Non-Fungible Tokens (NFTs) to embody distinct and diverse Characters. Each of these Characters possesses a set of distinctive traits and attributes, ensuring a captivating and varied gameplay experience. Engaging with this game allows players to encounter a wide array of possibilities, ranging from acquiring an exceptional champion stallion to discovering a Character specially suited for breeding purposes. The utilization of NFTs within the game enhances the sense of ownership and uniqueness, as players are presented with the opportunity to possess and engage with these one-of-a-kind digital entities. Community War is the biggest NFT gaming platform that is for PLAY-2-EARN. Users can start earning \$CTI when playing Community War starting Today. The purposed research model is as follow.

3.5.1. Cryptocurrency (CTIs) and Community WAR

Community INU, is a decentralized deflationary token. Its is a peer-to-peer digital currency and an open-source project. It's a unique merger of 3 types of earning.

*Proof of Gaming^{[1][2]}

*Play to Earn^{[1][2]}

*Digital Marketing

Users^{[1][2]}earning^{[1][2]}playing Community War.

3.5.2. Community War

Sniper shooter, multiple enemy types, slow motion bullet effects, multiple rifles, two modes, eliminate terrorists and save civilian, includes helicopters and cars, three environments city and industrial, day and night & run mode, find target based on a narrative description. UI/UX design for all aspect ratios of Android phones, high fidelity 3d/2d models optimized for mobile platform, level environment design, VFX, sounds, integration of ads network, integration of in-app purchase, stars animation I, in-app purchase banner, 40 levels on 2 modes.

Figure 10: Purposed Research Model of Community WAR

(<https://play.google.com/store/apps/details?id=com.thirdwar.smsswap.sniper.game>)

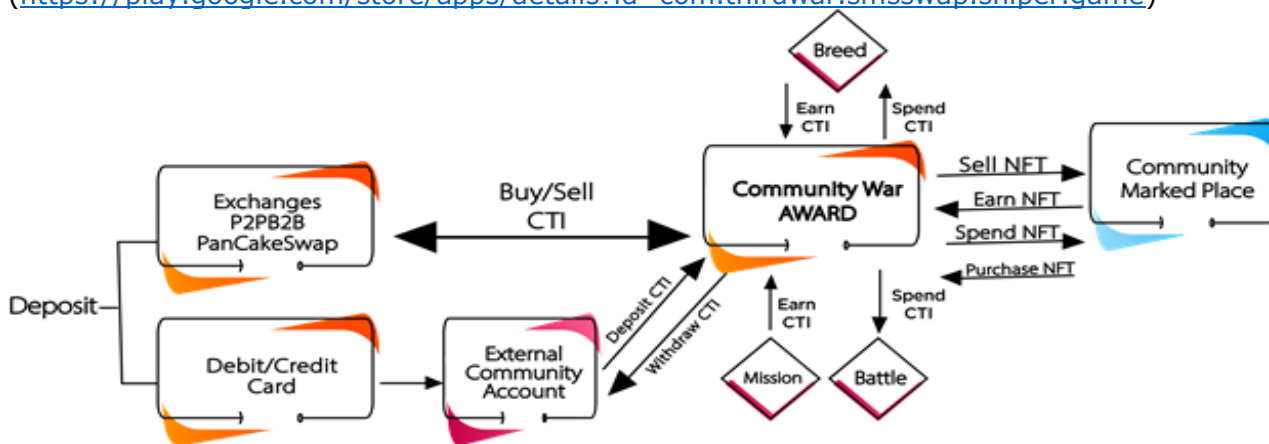

3.6. Data Collection, Instrumentation and Procedures

To gather data for this study, a survey was chosen as the data collection tool. Specifically, a Google Form was utilized, consisting of comprehensive and detailed questions pertaining to the metaverse activities that were relevant to the research objectives. The inclusion of detailed questions ensured that participants could provide comprehensive responses, enabling a thorough exploration of the core concepts and effective evaluation of the research variables. The survey questions, presented in Appendix A, focused on critical technical aspects related to blockchain, cryptocurrency, metaverse, and NFTs. The utilization of surveys aimed to capture participants' sentiments, experiences, and trust levels within a decentralized platform, as well as their understanding of the integration of the metaverse into the gaming realm. A sample size of 09 participants was selected to ensure valid data and facilitate in-depth analysis of the responses, allowing for further scrutiny and examination of the research findings.

3.7. Trustworthiness

The key concern was making sure readers could trust the results and that they could approve the research findings. One could ensure that the conclusions were pertinent, accurate, and generally reliable by constructing the evidence and giving the accuracy of the research (Zhou & Baptista Nunes, 2013).

4. Results

4.1. Case Study and reviews of Respondents

The nine selected gaming player are playing the community WAR game and first researcher give orientation to players and then they start the game. According to our survey participants, NFT is a digital asset that may be connected to other digital and physical assets as proof of ownership, such as GIF, JPEG, videos, and real estate. Following are the views of game player of community War,

Player 1, "NFT is a means of proving ownership of physical or digital assets that may be traded and gathered. Since NFT can now be used to demonstrate a painting's originality, it is now possible to identify Leonardo Da Vinci's forgeries. Additionally, as a holder of an NFT and a member of the community, you will receive benefits."

Using a digital wallet allows you to store NFTs. Through online stores like OpenSea, Rarible, SuperRare, Mintable, etc., NFTs can be purchased. All of them identified as collectors and owned at least one NFT from the online store OpenSea, though we also discovered two NFT creators who were currently engaged in a project.

Player 2, *as a creator, I'm presently engaged in a project. The future of the art world, in my opinion, is NFT. Each time your creation is sold, you as the creator will receive royalties.* User faces some kind of issue like withdrawal and they are dissatisfied from the procedure of withdrawal in the community war game, specifically after winning the game.

Player 3, *"After completing some level I received CTI but there is no proper way to withdraw my reward, play to Earn options is working perfectly but company need to design more easiest option for place your Adds".*

Another player respond dissatisfied from community war game by saying that there is no proper mechanism of earning and it is no attractive one so organization need to improve it and also give focus on game stages and missions.

Player 4, *"Sorry but this game app very slow not good working" my opinion it need to improvement for smooth working. Secondly there is no proper Earning and not clear mission and targets of game. You needed to update and in short I am not satisfied but company should consider every players review and work more to make it better.* One of the key player praise the concept of NFT gaming and blockchain technology and he said it's a good idea for the economy of south Asia specifically for Pakistan and he also identify one of the main point which is need to upgrade in community War game that is placement of add with easy method.

Player 5, *"outstanding game and income opportunity for everyone.... One of the best game in the world I enjoyed a lot playing it and Outstanding game and income opportunity for everyone... the idea of digital marketing in game is too awesome but there is no option to place your add here."*

Another main and expert player give positive response to the community war game and highlight the main points which are necessary for the growth of company and as well as for the community and country. He said that he is not interested in starting but after playing it he never stop to play and playing again and again. He appreciated the way whom company promotes which is digital marketing.

Player 6, *"the combination of Play2Earn & NFT characters concept we can create a big change in gaming industry and usually I don't like games but I like to play this game over and over again. This is a very interesting game and gives a big change for digital marketing. Really like it."*

According to our interview with the respondents, the majority said they were interested in NFT games but were still unsure because they were unsure about the game's system and they had received negative press, which made them more cautious. They generally said they spent between 2-4 hours a day playing games. A NFT game dubbed community war was, however, already played by some of the responders.

Player 7, *"I was intrigued in playing NFT games, but I still don't fully comprehend how the game works, therefore I haven't done so as of yet."*

Player 8, *"I was intrigued in playing these NFT games, but I'm a little hesitant to do so now that they've received some bad press recently due to incidents like rug pulls."* Our interview revealed that several respondents believed NFT games were more focused on a pay-to-play than a pay-to-win business model. Some NFT games, according to one respondent, combine both business models specifically for the digital marketing.

Player 9, *"Since the majority of these NFT games require you to purchase certain assets before you can play them, they combine both features in my case. This is because the player's income is more likely to vary depending on how much they spend. Due to the popularity of these types of games among young people, we can provide a supplemental game and utilize it to advertise our products."*

4.2. NFT Gaming and Upgraded Version of Community War

NFTs, to exchange documents speculative commercial centers rousing numerous in the business to take on the innovation for a few imaginative changes to how they — and their players — can bring in cash. Game creators consider this innovation to be a chance to additional form in-game commercial centers given a drawn-out shift toward treating computer games as a help instead of as a discrete item bought a solitary time. Our essential objective is to comprehend the execution around virtual things that can be exchanged over a block chain-based climate and to get a smidgen of how these things work. By fostering this sort of game, we can investigate the designers' implementation challenges while making this game. After the mitigating the loopholes of community war game the new and updated versions of game is based on following up gradation and this up gradation are based on the observation of players which take part in community war game and all are discussed in case study. After implementing all up gradation researcher found the new and upgraded version of community war game that is "COMMUNITY POOL".

4.3. Community Pool Club

The goal of the project is to create a decentralized, blockchain-based pool game that can be played on the web. Players will participate in PvP (player versus player) matches using cryptocurrency. The stack holders of game are, Players, Individuals who will be participating in the game and potentially wagering cryptocurrency on matches. Developers: The team responsible for building and maintaining the game. Investors: Parties that are interested in funding the development and promotion of the game. Working of community pool club;

- A fully functional web3 8-Ball game that is built on top of a decentralized platform
- A system for players to participate in matches using cryptocurrency
- A decentralized ledger that stores all game data to ensure fairness and transparency
- A system for players to view their match history

Figure 11: Final Model of Community POOL Game

<https://play.google.com/store/apps/details?id=com.cpc.communitypoolclub>

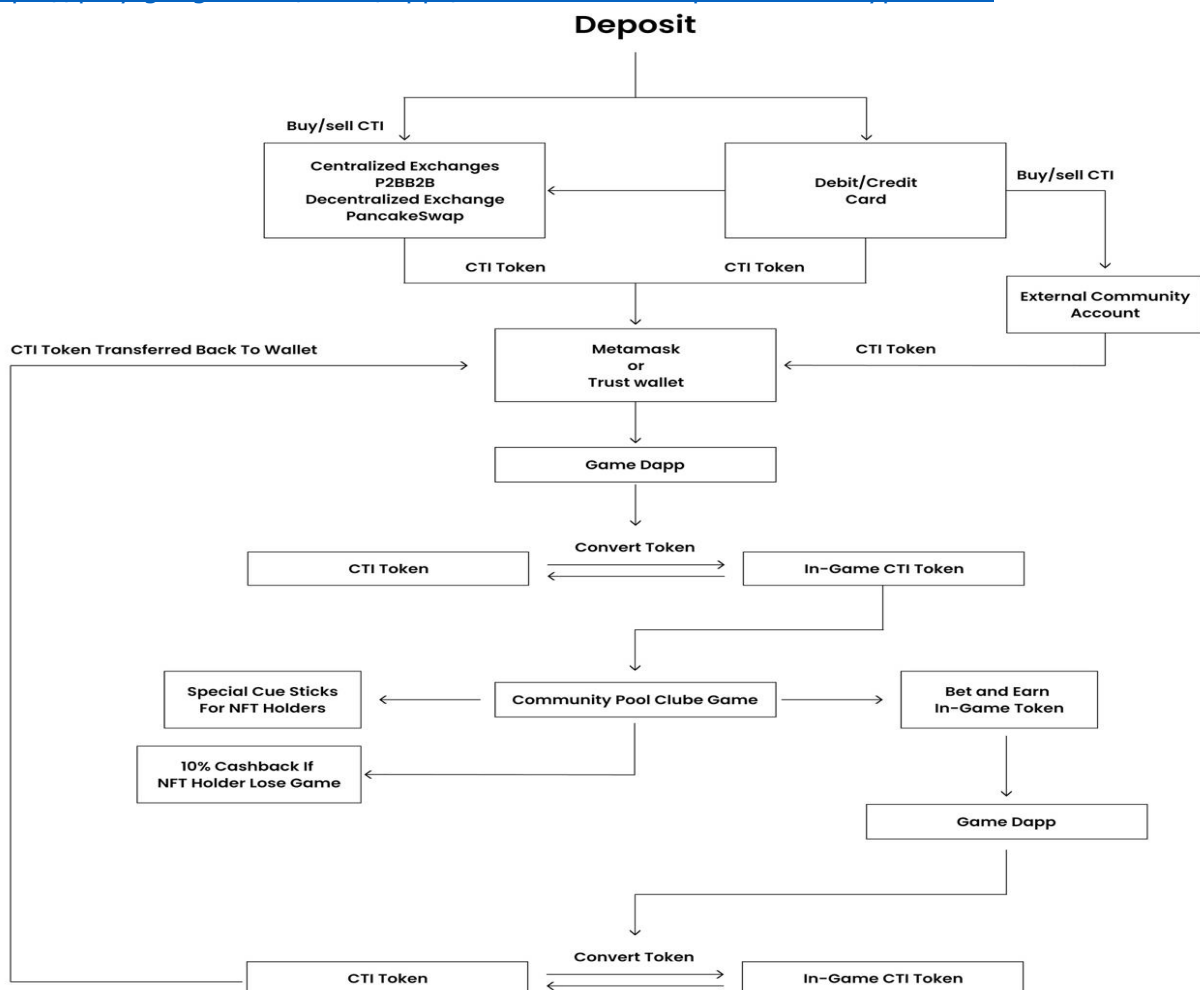

4.3.1. Gaming IDE and Development Steps of Community War

The IDE is a Unity3dGaming for developmental purposes. Since it is multi-device platform and a renowned strong gaming motor too.

Figure 11a: Community War IDE

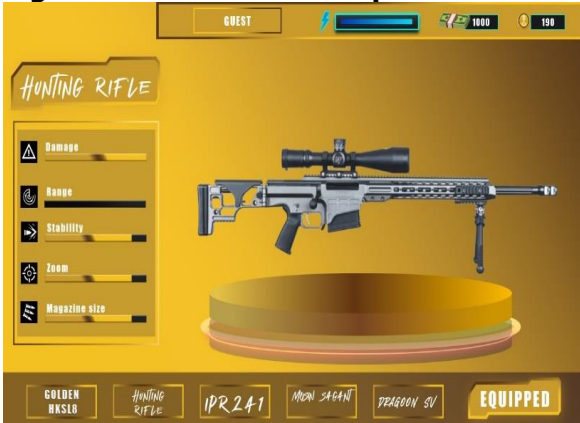

Figure 12b: Community War MarketingPre



- Development Steps Front & Backend Development
- Digital Marketing
- Block Chain Platform Implementation
- Registration: through digital wallet
- Tokens of Game: CTI

Figure 12: Token's Example in Community War



4.4 Development Steps of Community Pool

4.4.1. Pre-Development Steps

Essentially, it's important to set up a server that will store your one-of-a-kind in-game things.

4.4.2. Front & Backend Development

Generally speaking, designers use an expansive range of programming, including the actual motor, Visual Studio code supervisor, different modules, and so forth.

Figure 13:Community Pool IDE



4.4.3. Marketing

Whenever it's done up the whole framework design, coded all mechanics, and finished other back-end stuff, now is the right time to send off the promoting effort. Expounding on ads and promotions, it's vital to remember investors' inclinations.

Figure 15: Community Pool Marketing

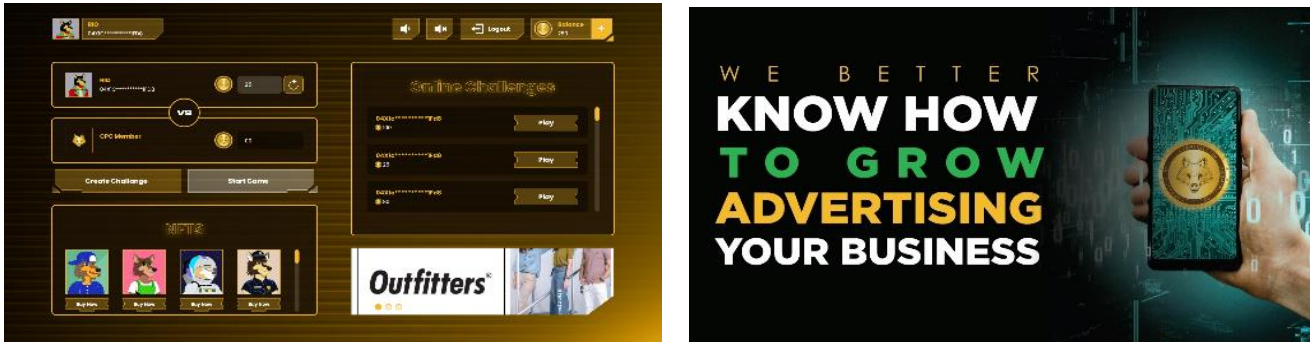

4.4.4. Block Chain Platform

The Community INU stage gives the element of purchasing, selling, trading, and gathering in-game things. Its openly furnished SDK is incorporated capable with the Unity3d gaming motor.

4.4.5. Implementation

Designer Enlistment, Game Tokens, Programming interface enrollment, and so forth. Everything the strategy to foster the game is trailed by the guidance given by Community INU allowed to utilize module guidance.

4.4.6. Registration

To utilize the Community INU include, first, it is expected to enlist the game with Community INU, which their group does as such upon straightforward email demand.

Figure 16: Community Pool Registration



4.4.7. Tokens of Game

When the Community INU group gets the list of the things, they create a Game Token Like Pool Clubs, Pool tools etc.

Figure 17: Token's Example in Community Pool

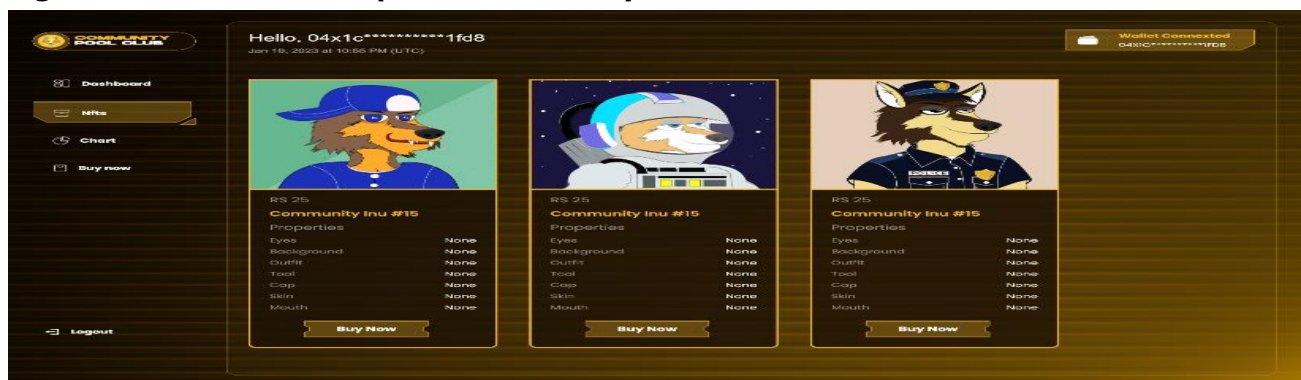

4.5. Gaming & Earning Flow

The Communication Flow of game is that the player will begin a game meeting and gather virtual things. Then will stop the meeting and will get to Game Stock: Players will actually want to enlist or sign into CTI from here.

4.5.1. One or more Tokens

For this situation game will be adjusted with Digital market account by moving all things and adding them to stock inside the game.

4.5.2. Game API's

Working with NFTs is troublesome on the grounds that edge cases habitually emerge while parsing NFT information on block chains. NFT APIs dispose of every such deterrent and make it simple to work with non-fungible tokens. Assignments like extricating information from different brilliant agreements and incorporating it into an application can be performed without extra exertion. With the right NFT APIs, you can get information related to all non-fungible tokens enrolled on a block chain.

4.5.3. Implementation Results

The aforementioned advancements have empowered game designers to create virtual items within the gameplay, which can then be made available on the CTI's platform for trading among players. This integration introduces real economic value to the virtual assets that are acquired by both players and designers on a per-item basis. Such implementation necessitates a deep understanding of APIs and authentication processes from the technical perspective, emphasizing the importance of experience on the engineering side. In ensuring the security of its platform, CTI relies on the inherent security provided by the blockchain's robust design, which safeguards the integrity and protection of the system.

5. Discussion

In the course of this research, it became evident that the development of NFTs and the metaverse is still in its early stages, and diverse perspectives and opinions prevail. The respondents expressed the belief that NFTs and the metaverse are inevitable and hold the potential to generate new opportunities for various stakeholders, including digital artists, developers, technical consultants, and others within the user, gaming community, and accounting domains. However, it is worth noting that the regulatory landscape for NFTs remains unclear, presenting significant risks such as money laundering, rug pull scams, wallet theft, and hacking, which instilled caution among our respondents. Moreover, one respondent conveyed that NFTs were highly speculative, leading them to prefer investing in more secure financial instruments like stocks, bonds, and mutual funds, which they deemed less volatile. A decentralized gaming biological system depends on block chain and NFTs, which gives more capacity to gamers. A couple of year's prior, when web-based games were presented, there were sure blemishes in their design. Accordingly, it would become simpler for gamers to sell or trade their crypto resources or NFTs with different players or similar stage clients as well as the other gaming stages effortlessly.

5.1. Distributed Platform

Not at all like public block chains, are it as yet concentrated on game stages. The information, gaming characters, and resources are still in the possession of the gaming stage proprietor. Normal clients need to pay cash to join the stage and utilize things like this, and they lose participation honors not long after stopping the gaming stage.

5.2. Marking Amazing Open Doors

NFTs are presently being utilized to raise brand mindfulness. Renowned business brands can present advanced fine arts of their items as NFTs that can be utilized as gaming rewards. An NFT gaming stage advancement organization can add new imaginative components to in-game NFTs for catching the interest of players.

5.3. Investing Heavy Capitals & Revenue

Besides, the absence of admittance to capital challenged people designers that need to work with energy and resourcefulness. High-end, multi-player, complex, technique, and combat zone games require ventures that can go up to a huge number of dollars and an improvement

period that can extend into years. Then again, cloned hyper-easygoing short, lightweight, immediately playable games can be made in seven days at an expense of \$2K to \$4K.

5.4. Lack of Trainings

The gaming business is likewise confronted with a deficiency of a prepared labor force that incorporates engineers and creators. "Pakistan produces around 20K IT graduates consistently, yet they for the most part go work for programming houses" (Attarwala, 2022). Colleges ought to urge individuals to investigate this vocation choice instead of simply pushing individuals towards additional customary streams".

5.5. NFT Games and Digital Marketing

Digital Marketing can be an important tool for NFT games, both socially and economically. Here's how: **Social Aspects, Raising Awareness:** Digital marketing can help increase awareness of an NFT game and its features among players, collectors, and investors. This can help create buzz and excitement around the game, and increase its visibility in the NFT community. **Building Community:** Strong community-based NFT games for development and digital marketing can help foster a sense of community around a particular game. By leveraging social media and other digital channels, game developers can connect with their audience and create engaging content that encourages interaction and collaboration. **Branding:** Effective digital marketing can help establish a strong brand identity for the NFT game. By creating consistent messaging and branding across all digital channels, game developers can create a recognizable and memorable brand that differentiates their games from their competitors. **Economic aspects: Increase Revenue:** Digital marketing can help NFT games generate more revenue by increasing the number of transactions and NFT sales. By driving targeted traffic to a game's website or landing page, developers can increase the number of potential buyers and collectors. **Profitable Marketing:** Digital marketing is often more profitable than traditional marketing channels. By using social media, email marketing, and other digital tactics, game developers can reach large audiences without spending a lot of money on advertising. **Long-term growth:** Effective digital marketing can help NFT games achieve long-term growth by building a strong community of gamers, collectors, and investors. Therefore, as an NFT gaming platform, we can attract people from all over the world to offer their services/products to our community. For example, if a European company wants to offer its services/products in this region where we live, it can choose to involve the community we have, and it can do this by looking at the number of people and their demographics.

5.6. NFT Games and Asia Pacific Region

NFT games have the potential to bring multiple benefits to Pakistan including economic, social and cultural benefits. Here are some of the ways NFT games can benefit Pakistan: **Economic Benefits:** NFT games have the potential to create new economic opportunities for Pakistani game developers, artists and entrepreneurs. By leveraging blockchain technology, NFT games can provide game developers with new revenue streams, allowing them to turn game assets into unique digital collectibles that can be bought, sold, and traded on the marketplace. This helps to stimulate innovation and entrepreneurship in the gaming industry in Pakistan and create new jobs. **Social benefits:** NFT games can also help promote social interaction and community building in Pakistan.

5.7. Contribution of Community War and Community Pool

Community war has empowered numerous specialists and gatherers to score enormous benefits from the deals of their works. NFT merchants can draw in purchasers straightforwardly, without delegates, because of block chain innovation. That empowers makers to diminish costs, partaking in the full advantages of their work. You just have to play earn tokens and exchange it. Starting a community pool game, management team requires a considerable amount of effort and investment. With this huge investment, managers are understood ably only comfortable giving a great team to a reliable gaming community. To recruit a dedicated scholar, most managers recruit from their known familiar network of friends and gamer-friends. Scholars who are gamers from the start are preferred because gamers can quickly grasp the gameplay of community pool, and they do not need to learn everything from scratch. Guidelines also shared insights on who are reliable players, friends are preferred because my friends are heavy gamers and can process the gameplay easily. A blockchain game using NFTs (Non-Fungible Tokens) might contribute in a number of ways, including:

- New Economy Creation: NFT blockchain games allow for the development of new economies that the community may control. By engaging in community events, buying and selling NFTs, and playing the game, individuals may earn bitcoin in these economies.
- Fostering Community Engagement: In a shared virtual environment, NFT blockchain games may bring people together and foster a feeling of community. On missions and other activities, players may work together, offer advice and tactics, and create enduring bonds.
- Boosting innovation: NFT blockchain games are still a very new idea, therefore there is lots of possibility for creativity. New quests, activities, and game mechanic suggestions from the community can be used by developers to improve the game.
- Philanthropic Assistance: NFT blockchain games may help raise money for good causes by contributing a piece of the revenue from NFT sales or gaming occasions. Players who are collaborating to improve the world may feel a feeling of purpose and community as a result of this.

After developing and publishing Community War in the first phase of NFT game development and examining its strengths, weaknesses, limitations and areas for improvement, we decided to work hard to build a Community Pool game with better features and functionality.

6. Conclusion

This study examines NFT and the metaverse from several angles, examining its benefits and drawbacks as well as their potential. Based on their findings, researchers concluded that NFT and the metaverse are still in their early stages of development and are the subject of many divergent viewpoints. NFT and metaverse, according to some responses, are imminent and may open up new prospects for gamers, users, and accountants like digital artists, developers, and technical consultants. Researchers had limitations, firstly, our sample size is relatively small (18 respondents) because the researcher's time was limited and it was difficult to find respondents who understood the fundamental knowledge of NFT and metaverse and were willing to speak up about their opinion on these new findings. Secondly, this research only focuses on three perspectives (users earning, gaming community, and marketing) who understand NFT.

The NFT ecosystem has other stakeholders (e.g., investors) who might have different opinions (Sharma et al., 2023). Furthermore, findings found by researchers were only based on the interview, which possibly can be biased. But researchers reduce the risk of bias by using the question that had been in the previous research, creating predetermined questions, determining the scope before conducting the interview. In the future, researchers hope that the next research can be complemented by observational studies. Last but not least, the majority of our respondents (08 out of 09) are male. It's hoped that the next research will have more female respondents to expand the perspective. Despite its limitations, it's hoped that the next research will have broader perspectives.

References

- Afzal, A., & Asif, A. (2019). Cryptocurrencies, blockchain and regulation: A review. *The Lahore Journal of Economics*, 24(1), 103-130.
- Angerer, M., Hoffmann, C. H., Neitzert, F., & Kraus, S. (2021). Objective and subjective risks of investing into cryptocurrencies. *Finance Research Letters*, 40, 101737. doi:<https://doi.org/10.1016/j.frl.2020.101737>
- Aras, S. (2021). Stacking hybrid GARCH models for forecasting Bitcoin volatility. *Expert Systems with Applications*, 174, 114747. doi:<https://doi.org/10.1016/j.eswa.2021.114747>
- Attarwala, F. S. (2022).
- Baur, D. G., Dimpfl, T., & Kuck, K. (2018). Bitcoin, gold and the US dollar—A replication and extension. *Finance Research Letters*, 25, 103-110. doi:<https://doi.org/10.1016/j.frl.2017.10.012>
- besancia (Producer). (2022, 07 27). nft-market-report-q2-2022. *nonfungible.com*. Retrieved from <https://nonfungible.com/>
- Cass, J. (2022). types-of-nfts.
- Celik, Y., Petri, I., & Barati, M. (2023). Blockchain supported BIM data provenance for construction projects. *Computers in Industry*, 144, 103768. doi:<https://doi.org/10.1016/j.compind.2022.103768>

- Chen, T., Guo, W., Gao, X., & Liang, Z. (2021). AI-based self-service technology in public service delivery: User experience and influencing factors. *Government Information Quarterly*, 38(4), 101520. doi:<https://doi.org/10.1016/j.giq.2020.101520>
- Ciaian, P., & Rajcaniova, M. (2018). Virtual relationships: Short-and long-run evidence from Bitcoin and altcoin markets. *Journal of International Financial Markets, Institutions and Money*, 52, 173-195. doi:<https://doi.org/10.1016/j.intfin.2017.11.001>
- Corbet, S., Lucey, B., Urquhart, A., & Yarovaya, L. (2019). Cryptocurrencies as a financial asset: A systematic analysis. *International Review of Financial Analysis*, 62, 182-199. doi:<https://doi.org/10.1016/j.irfa.2018.09.003>
- Dean, I. (2022). make-and-sell-an-NFT.
- Dewey, J. (2021). blockchain-laws- and-regulations/usa.
- Frankenfield, J. (2022). cryptocurrency.asp.
- Garcia-Jorcano, L., & Benito, S. (2020). Studying the properties of the Bitcoin as a diversifying and hedging asset through a copula analysis: Constant and time-varying. *Research in International Business and Finance*, 54, 101300. doi:<https://doi.org/10.1016/j.ribaf.2020.101300>
- Gil-Alana, L. A., Abakah, E. J. A., & Rojo, M. F. R. Research in International Business and Finance. doi:<https://doi.org/10.1016/j.ribaf.2019.101063>
- Hattori, T. (2020). A forecast comparison of volatility models using realized volatility: Evidence from the Bitcoin market. *Applied economics letters*, 27(7), 591-595. doi:<https://doi.org/10.1080/13504851.2019.1644421>
- Heilbuth, H. (2022). nft-explained.
- Lansky, J. (2018). Possible state approaches to cryptocurrencies. *Journal of Systems integration*, 9(1), 19.
- Lestiyo, I. (2021). 2021 Gaming Report, Unity insights from 2020 and predicted trends for 2021. *Unity Publisher Operations team*.
- Li, R., Li, S., Yuan, D., & Zhu, H. (2021). Investor attention and cryptocurrency: Evidence from wavelet-based quantile Granger causality analysis. *Research in International Business and Finance*, 56, 101389. doi:<https://doi.org/10.1016/j.ribaf.2021.101389>
- Liu, W., Liu, X., Shi, X., Hou, J., Shi, V., & Dong, J. (2023). Collaborative adoption of blockchain technology: A supply chain contract perspective. *Frontiers of Engineering management*, 10(1), 121-142. doi:<https://doi.org/10.1007/s42524-022-0239-8>
- Maloul, R., & Chevalier, L. Study on digital ownership in the gaming industry and analysis of a possible new approach via the implementation of blockchain and non-fungible tokens.
- Mba, J. C., & Mwambi, S. (2020). A Markov-switching COGARCH approach to cryptocurrency portfolio selection and optimization. *Financial Markets and Portfolio Management*, 34, 199-214. doi:<https://doi.org/10.1007/s11408-020-00346-4>
- Mba, J. C., Pindza, E., & Koumba, U. (2018). A differential evolution copula-based approach for a multi-period cryptocurrency portfolio optimization. *Financial Markets and Portfolio Management*, 32, 399-418. doi:<https://doi.org/10.1007/s11408-018-0320-9>
- Peng, Y., Albuquerque, P. H. M., de Sá, J. M. C., Padula, A. J. A., & Montenegro, M. R. (2018). The best of two worlds: Forecasting high frequency volatility for cryptocurrencies and traditional currencies with Support Vector Regression. *Expert Systems with Applications*, 97, 177-192. doi:<https://doi.org/10.1016/j.eswa.2017.12.004>
- Sapuric, S., Kokkinaki, A., & Georgiou, I. (2022). The relationship between Bitcoin returns, volatility and volume: asymmetric GARCH modeling. *Journal of Enterprise Information Management*, 35(6), 1506-1521. doi:<https://doi.org/10.1108/JEIM-10-2018-0228>
- Sharma, P., Namasudra, S., Chilamkurti, N., Kim, B.-G., & Gonzalez Crespo, R. (2023). Blockchain-based privacy preservation for IoT-enabled healthcare system. *ACM Transactions on Sensor Networks*, 19(3), 1-17. doi:<https://doi.org/10.1145/3577926>
- Sherry, J. L., Greenberg, B. S., Lucas, K., & Lachlan, K. (2012). Video game uses and gratifications as predictors of use and game preference. In *Playing video games* (pp. 248-262): Routledge.
- Umar, M., Rizvi, S. K. A., & Naqvi, B. (2021). Dance with the devil? The nexus of fourth industrial revolution, technological financial products and volatility spillovers in global financial system. *Technological Forecasting and Social Change*, 163, 120450. doi:<https://doi.org/10.1016/j.techfore.2020.120450>
- Unity (Producer). (2021a). 2021-game-report. *create.unity.com*. Retrieved from <https://create.unity.com/2021-game-report>
- Unity (Producer). (2021b, February 4). Unity Announces Fourth Quarter and Full Year 2020 Financial Results. *investors.unity.com*. Retrieved from

<https://investors.unity.com/news/news-details/2021/Unity-Announces-Fourth-Quarter-and-Full-Year-2020-Financial-Results/default.aspx>

- Uzonwanne, G. (2021). Volatility and return spillovers between stock markets and cryptocurrencies. *The Quarterly Review of Economics and Finance*, 82, 30-36. doi:<https://doi.org/10.1016/j.qref.2021.06.018>
- Wang, J., Xue, Y., & Liu, M. (2016). *An analysis of bitcoin price based on VEC model*. Paper presented at the 2016 international conference on economics and management innovations.
- working-of-blockchain. (2020).
- Xiao, X., Zhang, Y., Zhu, Y., Hu, P., & Cao, X. (2023). FingerChain: Copyrighted Multi-Owner Media Sharing by Introducing Asymmetric Fingerprinting into Blockchain. *IEEE Transactions on Network and Service Management*.
- Yannakakis, G. N., & Togelius, J. (2018). *Artificial intelligence and games* (Vol. 2): Springer.
- Zhou, L., & Baptista Nunes, M. (2013). Doing qualitative research in Chinese contexts: Lessons learned from conducting interviews in a Chinese healthcare environment. *Library Hi Tech*, 31(3), 419-434. doi:<https://doi.org/10.1108/LHT-11-2012-0104>